

SINGER
111W104,W105

LIST OF PARTS

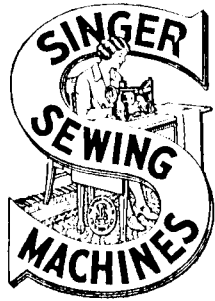

MACHINES Nos. 111w104 and 111w105

THE SINGER MANUFACTURING COMPANY

INDEX

	PAGE
ACCESSORIES	19
BOBIN WINDER	19
FEED DOGS	22
FOOT LIFTER	23
KNEE LIFTER	20
MACHINE No. 111w104	7
" " 111w105	17
MISCELLANEOUS PARTS	23
NUMERICAL LIST OF PARTS	25
PRESSER FEET	22
THREAD UNWINDER	21
THROAT PLATES	23

From the library of: Diamond Needle Corp

Instructions for Ordering

In ordering from this list, use **ONLY** the **PART** number in the **FIRST** column

The number stamped on a Sewing Machine Part is the number of the Single Part only, except when the part includes Set Screws, Clamping Screws, Studs and Rollers Spun on, Small Wires riveted, or Parts soldered together, etc., which it is necessary to furnish in combination.

Every combination of parts sent out has its specific number which, although not stamped on Parts (except in above cases) must be used when ordering the combination.

Each number always indicates the **SAME PART** in whatever list it appears, or for whatever Machine.

The letters after some of the numbers indicate the style of finish only, as follows:

- A. Hardened, Polished and Plated
- B. Polished and Plated.
- C. Hardened only.
- D. Polished only.
- E. Soft, not polished.
- F. Hardened and Polished.
- H. Blued.
- J. Nickel Plated only.
- R. Merlized.
- Y. Black Nickel Plated only.

These letters **MUST BE USED** when they appear in the list and **AFTER** the number, as in the list.

- 200001 to 201500 and 350001 to 351500 are Screw Numbers
- 201501 to 201800 and 351501 to 351800 are Nut Numbers.
- 201801 to 202000 and 350801 to 352000 are Roller Numbers.
- 202001 to 350000 are Numbers of Machine Parts.

The figures in the second column refer only to the plate in which the illustration of the part is shown and are **NOT TO BE USED** in ordering

Two or more numbers over a cut indicate that the difference between such parts is not visible in an illustration.

Parts marked with an asterisk (*) are furnished only when repairs are made at the factory.

LIST OF PARTS COMPLETE

FOR

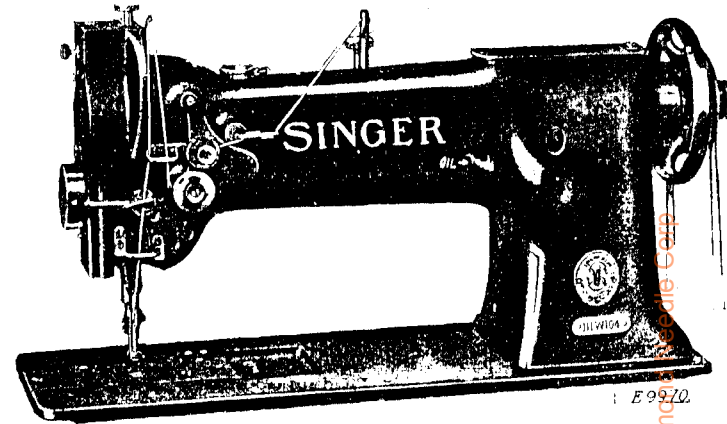

MACHINE No. 111w104

VERTICAL HOOK. HIGH SPEED. COMPOUND
FEED. ALTERNATING PRESSERS.
KNEE LIFTER

For Leather Gloves, Combination Leather and
Canvas Gloves, etc.

No.	Plate	Name
*240190		Arm with 202135
224002	14347	" Cap
200278u	14327	" " Screw
202248	14327	" " " Washer
204235	14327	" Position Pin (2)
200004e	14327	" Screw (3)
202005	14327	" " Washer (3)
240102	14359	" Shaft with 200357e and 224392
240802		" " Bushing (back) with 202244
202244		Arm Shaft Bushing (back) Oil Packing (wick)
200338c	14327	Arm Shaft Bushing (back) Set Screw
207080	14347	Arm Shaft Bushing (front) with 202244

From the library of: Diamond Sewing Co.

Parts for Machine No. 111w104

No.	Plate	Name
202244	----	Arm Shaft Bushing (front) Oil Packing (wick)
200502b	14327	Arm Shaft Bushing (front) Oil Packing Thumb Screw
200338c	14327	Arm Shaft Bushing (front) Set Screw
224103	14348	Arm Shaft Connection Belt
224104	14347	" " " " Pulley with 200327c, 200602e and two 202253
200602e	14327	Arm Shaft Connection Belt Pulley Position Screw
200327c	14327	Arm Shaft Connection Belt Pulley Set Screw
202253	14327	Arm Shaft Connection Belt Pulley Spring Flange
224113	14327	Arm Shaft Connection Belt Timing Collar with 200113f
200113f	14327	Arm Shaft Connection Belt Timing Collar Set Screw
224139	14327	Arm Shaft Connection Belt Timing Plate
200164b	14327	Arm Shaft Connection Belt Timing Plate Screw (2)
224392	---	Arm Shaft Oil Packing (wick)
200357e	14327	" " " " Stop Screw
234147	14359	Balance Wheel (belt groove 2 7/8 in. diam.) with 200328c and 200335c
200328c	14327	Balance Wheel Position Screw
200335c	14327	" " " " Set Screw
*240103	----	Bed
54897	14327	" Oil Cup
240003	14347	" Slide (back)
223811	14338	" " " " Stop
223812	14338	" " " " Spring
240004	14347	" " (front)
203470	13232	Bobbin
*203520	---	" Case
203648	13232	" " Latch
*202056	---	" " " " Pin
203473	13232	" " " " Plunger
203474	14338	" " " " Spring
224004	14338	" " Opener
224005	14338	" " " " Lever with 201349c, 201542c and 203101
201349c	13232	Bobbin Case Opener Lever Driving Screw Stud
201542c	13232	Bobbin Case Opener Lever Driving Screw Stud Nut

Parts for Machine No. 111w104

No.	Plate	Name
203101	----	Bobbin Case Opener Lever Driving Screw Stud Oil Packing (wick)
223622	13232	Bobbin Case Opener Lever Hinge Stud with 202277
202277	---	Bobbin Case Opener Lever Hinge Stud Oil Packing (wick)
200364c	14338	Bobbin Case Opener Lever Hinge Stud Set Screw
223623	13232	Bobbin Case Opener Lever Link
200118b	13232	" " " " Screw
203214	13232	" " Tension Spring
200984c	14338	" " " " Regulat- ing Screw
200594c	13232	Bobbin Case Tension Spring Screw
203216	---	" " Washer (cloth)
203521	14338	Bobbin Case complete, Nos. 200594c, 200984c, 202056, 203214, 203216, 203473, 203474, 203520 and 203648
240179	14359	Face Plate
202135	13232	" " Position Pin
200473b	13232	" " Thumb Screw
240037	14339	Feed Bar
240038	---	" " 240037 with 224052, 225837 and 350197e
201223c	13232	Feed Bar Hinge Screw (driving)
201518e	13232	" " " " Nut
240110	14351	" Dog, 46 needle hole, for needle sizes 16 and 18
200106e	13232	Feed Dog Screw (2)
237565	14339	" Driving Connection with 200049b and 202330
201171c	13232	Feed Driving Connection Hinge Screw
201517b	13232	Feed Driving Connection Hinge Screw Nut
202277	---	Feed Driving Connection Hinge Screw Oil Packing (wick)
202330	----	Feed Driving Connection Oil Pack- ing (wick)
200049b	13232	Feed Driving Connection Pinch Screw
237521	14339	Feed Driving Eccentric Regulating Bracket
237043	---	Feed Driving Eccentric Regulating Bracket 237521 with 224108, two each 200256b and 201525e
224108	14339	Feed Driving Eccentric Regulating Bracket Flange with 200383c and 200437c

Parts for Machine No. 111w104

No.	Plate	Name
200437c	14338	Feed Driving Eccentric Regulating Bracket Flange Position Screw
200383c	14357	Feed Driving Eccentric Regulating Bracket Flange Set Screw
200256d	14338	Feed Driving Eccentric Regulating Bracket Hinge Screw
201525e	14338	Feed Driving Eccentric Regulating Bracket Hinge Screw Nut
202301	14338	Feed Driving Eccentric Regulating Bracket Plunger
237523	14338	Feed Driving Eccentric Regulating Bracket Plunger Spring
200607c	14338	Feed Driving Eccentric Regulating Bracket Plunger Spring Stop Screw
200256d	14338	Feed Driving Eccentric Regulating Bracket Stop Screw
201525e	14338	Feed Driving Eccentric Regulating Bracket Stop Screw Nut
200429c	14338	Feed Driving Eccentric Regulating Screw
200383c	14357	Feed Driving Eccentric Regulating Screw Check Screw
223650	14348	Feed Driving Rock Shaft
240031	---	" " " " 223650 with 201223c, 201518e and 240038
223652	14338	Feed Driving Rock Shaft Crank with 200019c
200019c	14338	Feed Driving Rock Shaft Crank Pinch Screw
202625	14338	Feed Driving Rock Shaft Stop Collar with two 200383c (2)
200383c	14357	Feed Driving Rock Shaft Stop Collar Set Screw
224154	14338	Feed Lifting Cam with 201220c
224052	14338	" " " Fork with 200173d and 223655
350197e	14338	Feed Lifting Cam Fork Screw
225837	14338	" " " " " Washer
223655	-	" " " Oiling Felt
200173d	14338	" " " " " Screw
201220c	14338	" " " Set Screw
224122	14339	" Regulating Spindle with 202311, 202443 and 202619
*202311	---	Feed Regulating Spindle Head
202443	14338	" " " " Pin
202619	14338	" " " " Position Pin

Parts for Machine No. 111w104

No.	Plate	Name
*224016	-	Hook (sewing)
224017	14357	" 224016 with 203525, 224025, two each 200590n and 201253f
240122	-	Hook and Bobbin Case complete, Nos. 203524 and 224017
224019	14338	Hook Bushing (lower) (bronze)
200364c	14338	" " " Set Screw
224020	14338	" " (upper) (bronze)
200446c	14338	" " " Position Screw
223867	13234	" Driving Gear (spiral) with 200362c and 201222c
201222c	13234	Hook Driving Gear Position Screw
200362c	13234	" " " Set Screw
224021	14357	" " Pinion (spiral) with two 200382c
200382c	14357	Hook Driving Pinion Set Screw
224022	-	" " " Thrust Washer
240017	14359	" " Shaft
224111	14339	" " " Bushing (back) with 202244
202244	-	Hook Driving Shaft Bushing Oil Packing (wick)
227529	14339	Hook Driving Shaft Bushing (front)
200327c	14327	" " " " Set Screw (2)
224112	14339	Hook Driving Shaft Connection Belt Pulley with 202253 and two 201254c
201254c	14357	Hook Driving Shaft Connection Belt Pulley Set Screw
202253	14327	Hook Driving Shaft Connection Belt Pulley Spring Flange
203525	14357	Hook Gib
201253f	13234	" " Screw
224024	14339	" Saddle with 200009e, 200446c, 224019, 224020 and two 200364c
223681	14339	Hook Saddle Bearing
200335c	14327	" " " Set Screw
240018	14359	" " Oil Guard
240019	-	" " " " Felt
200160e	14350	" " " " Screw (2)
200009e	13234	" " Pinch Screw
200006e	13234	" " Screw
225585	13234	" " Washer
240123	-	Hook Saddle complete, Nos. 200118b, 223622, 223623, 224004, 224005, 224021, 224022, 224024 and 240122

Parts for Machine No. 111w104

No.	Plate	Name
224025	14357	Hook Washer
200590H	14357	" " Screw
237837	14347	Knee Lifter Connection Lever
200262H	14357	" " " " Hinge Screw
223684	14359	Knee Lifter Connection Lever Lift- ing Rod with 202302
202302	13234	Knee Lifter Connection Lever Lift- ing Rod Cotter Pin
206628	14357	Knee Lifter Connection Lever Lift- ing Rod Spring
227227	14357	Knee Lifter Connection Lever Lift- ing Rod Spring Collar with 200113E
200113E	14327	Knee Lifter Connection Lever Lift- ing Rod Spring Collar Set Screw
240175	14359	Knee Lifter Lifting Lever
200262H	14357	" " " " Hinge Screw
240191	14358	Lifting Eccentric with 200382C and 200398C
240126	14358	Lifting Eccentric Connection
240171	14358	" " " " Crank with 200029E and 210933
210933	---	Lifting Eccentric Connection Crank Oil Packing (wick)
200029E	14472	Lifting Eccentric Connection Crank Pinch Screw
200398C	14472	Lifting Eccentric Position Screw
200382C	14357	" " Set Screw
240180	14472	" Lever
200996C	14472	" " Cap Screw
240181	14472	" " Link
350172C	14472	" " " Screw Stud
201524E	14472	" " " " " Nut
240133	14351	" Presser Foot
200074E	14472	" " " Screw
240136	14358	" Rock Shaft with 201524E and 350172C
240174	14350	Lifting Rock Shaft Bushing (2)
240169	14350	Needle Bar with 200125E, 200175D and 240170
202552	13234	Needle Bar Connecting Link
236073	14472	" " " " Oil Guard
200161D	14357	Needle Bar Connecting Link Oil Guard Screw
202333	14472	Needle Bar Connecting Link Stud with 202254

Parts for Machine No. 111w104

No.	Plate	Name
202254	---	Needle Bar Connecting Link Stud Oil Packing (wick)
200374C	13234	Needle Bar Connecting Link Stud Set Screw
200383C	14357	Needle Bar Connecting Link Stud Set Screw
208552	14472	Needle Bar Connecting Stud with 200086C and 202330
202330	---	Needle Bar Connecting Stud Oil Packing (wick)
200086C	14472	Needle Bar Connecting Stud Pinch Screw
202692	14358	Needle Bar Crank with 200335C, 200374C, 200383C, 200428C and 202333
240137	---	Needle Bar Crank 202692 with 202399, 202400, 202552, 208552 and 240139
203172	14472	Needle Bar Crank Friction Washer
200428C	14472	" " " Position Screw
200335C	14327	" " " Set Screw
240182	14358	" " Rock Frame
210910	13234	" " " " Hinge Stud with 202277
202277	---	Needle Bar Rock Frame Hinge Stud Oil Packing (wick)
200347C	13234	Needle Bar Rock Frame Hinge Stud Set Screw
202666	14472	Needle Bar Rock Frame Position Bracket
200098E	14472	Needle Bar Rock Frame Position Bracket Screw
223690	---	Needle Bar Rock Frame Rock Shaft
223691	14348	" " " " " " 223690 with 200387C and 210920
223692	14358	Needle Bar Rock Frame Rock Shaft Crank with 200029E
223693	14358	Needle Bar Rock Frame Rock Shaft Crank Connection with 202277
200833C	14357	Needle Bar Rock Frame Rock Shaft Crank Connection Hinge Screw
201522E	14357	Needle Bar Rock Frame Rock Shaft Crank Connection Hinge Screw Nut
202277	---	Needle Bar Rock Frame Rock Shaft Crank Connection Oil Packing (wick)
200029E	14472	Needle Bar Rock Frame Rock Shaft Crank Pinch Screw

Parts for Machine No. 111w104

No.	Plate	Name
202668 210920	14327 -----	Needle Bar Rock Frame Slide Block " " " " " "
		202668 with 201141c
201141c	14357	Needle Bar Rock Frame Slide Block Screw Stud
200387c	14357	Needle Bar Rock Frame Slide Block Screw Stud Set Screw
240170	14350	Needle Bar Thread Guide
200175d	14350	" " " " Screw
200125f	14350	" Set Screw
208566	14358	Presser Bar with 200074e
241535	14357	" " Bushing (lower)
207072	14357	" " " (upper)
200352c	14357	" " " Set Screw (2)
240193	14360	" " Lifter
200653c	14357	" " " Hinge Screw
208555	14360	" " Lifting Bracket with 200054e
200975f	14357	Presser Bar Lifting Bracket Guide Screw
200054e	14360	Presser Bar Lifting Bracket Pinch Screw
202337	14360	Presser Bar Position Guide
202338	14360	" " " " Lever with 200086f
200086f	14472	Presser Bar Position Guide Lever Pinch Screw
200352c	14357	Presser Bar Position Guide Set Screw
237836	14359	Presser Bar Spring (flat)
210949	14360	" " " Bracket with 200086c
200086c	14472	Presser Bar Spring Bracket Pinch Screw
201410f	14350	Presser Bar Spring Regulating Screw
200948f	14360	Presser Bar Spring Support Screw
240139	14360	Take-up Lever
202399	14360	" " Driving Stud with 202277
202277	-----	Take up Lever Driving Stud Oil Packing (wick)
202400	14360	Take-up Lever Hinge Stud with 202423
202423	-----	Take up Lever Hinge Stud Oil Packing (wick)
200363c	14360	Take up Lever Hinge Stud Set Screw

Parts for Machine No. 111w104

No.	Plate	Name
240023	14360	Tension Bracket with 201224b and 236060
200159f	14360	Tension Bracket Screw
234047	14350	" " " Socket
200368u	14350	" " " " Set Screw
240024	---	Tension Bracket complete, Nos. 13710, 200978u, 201199f, 204271, 223703, 223704, 223706, 237174, 240023, two each 200309e, 201572b and 244048
244048	13234	Tension Disc
236060	14360	" " Position Pin
223703	14361	" Release Lever
235576	14361	" " " Rod
200309e	14361	" " " Screw
223704	14361	" " Plunger
240141	14361	" " Slide
240142	14361	" " " Spring
204271	14361	" " Washer
13710	14361	" Spring
201224b	14361	" Stud
201572b	10881	" Thumb Nut
223706	14361	Thread Controller Disc
200978u	14361	" " " Screw
237174	14361	" " Spring
242117	14361	" " " Stop
200132e	14361	" " " " Screw
201199f	14361	" " Stud with 204925
200061c	14361	" " Set Screw
201572b	10881	" " " Thumb Nut
204925	14361	" " " Washer
202412	14361	" Guide
224040	14361	" "
210955	14361	" " (upper)
200582u	13232	" " Screw (3)
241755		" Lubricator Oil Pad (felt)
237845	14362	" " " " Holder
241757	14362	" " " " Retainer
241758	14362	" " " Reservoir
241759	---	" " " Wick
350280f	14362	" " Screw
214838	14362	" " " Washer
237846		Thread Lubricator complete, Nos. 214838, 237845, 241755, 241757 to 241759 and 350280f
240034	14361	Thread Retainer
200355u	14361	" " Set Screw

Parts for Machine No. 111w104

No.	Plate	Name
240145	14351	Throat Plate
691e	14362	" " Screw (2)
240183	14362	Vibrating Presser Bar
240184	14362	" " " Connecting Link
240185	14362	Vibrating Presser Bar Extension with 204264 and 240186
240186	14362	Vibrating Presser Bar Extension Collar
204264	14362	Vibrating Presser Bar Extension Collar Pin
202277	---	Vibrating Presser Bar Oil Packing (wick)
240188	14362	Vibrating Presser Bar Spring
350299e	14362	" " " Thumb Screw (pressure regulating)
240153	14344	Vibrating Presser Foot, 40 needle hole, with 201015e
201015e	14362	Vibrating Presser Foot Pinch Screw

MACHINE No. 111w105

VERTICAL HOOK. HIGH SPEED. COMPOUND
FEED. ALTERNATING PRESSERS.
KNEE LIFTER

For Automobile Work, Tents, Awnings, Furniture
Upholstering, Leather Goods, etc.

Same as Machine No. 111w104 with the following
exceptions:

No.	Plate	Name
*203670	-	Bobbin Case, in place of 203520
203669	14350	Bobbin Case complete, Nos. 200594e, 200984e, 202056, 203214, 203215, 203473, 203474, 203648 and 203650 in place of 203521
240111	14351	Feed Dog, 40 needle hole, for needle sizes 20 and 22, in place of 240110
*240041	-	Hook (sewing), in place of 224016
240042	14350	" 240041 with 203525, 224025, two each 200590n and 201253e, in place of 224017
240176	-	Hook and Bobbin Case complete, Nos. 203669 and 240042, in place of 240122
240167	14357	Hook Driving Pinion (spiral) with 200382e and 201220e, in place of 224021
201220e	14338	Hook Driving Pinion Position Screw
*240045	-	" " Shaft Connection Belt Pulley with 202253 and 240049, in place of 224112
*240046	-	Hook Driving Shaft Connection Belt Pulley Driving Flange with two 201254e
240047	14350	Hook Driving Shaft Connection Belt Pulley Driving Flange Locking Plunger
240048	14350	Hook Driving Shaft Connection Belt Pulley Driving Flange Locking Plunger Spring
240049	14350	Hook Driving Shaft Connection Belt Pulley Driving Flange Locking Plunger Spring Socket

From the library of **Harold North Corp**

Parts for Machine No. 111w105

No.	Plate	Name
201254c	14357	Hook Driving Shaft Connection Belt Pulley Driving Flange Set Screw
240050	-----	Hook Driving Shaft Connection Belt Pulley Safety Clutch complete, Nos. 240045 to 240048
240177	-----	Hook Saddle complete, Nos. 200118b, 223622, 223623, 224004, 224005, 224022, 224024, 240167 and 240176, in place of 240123
240130	14351	Lifting Presser Foot, for cording and general upholstery work, in place of 240133
240178	-----	Needle Bar Crank 202692 with 202399, 202400, 202552, 208552 and 241518, in place of 240137
241518	14350	Take-up Lever, in place of 240139
240154	14351	Vibrating Presser Foot, 40 needle hole, with 201015e, in place of 240153

ACCESSORIES

FOR MACHINE No. 111w104

No.	Plate	Name
200157b	14335	Attachment Screw
200861b	14362	Bed Slide (back) Locking Thumb Screw
203470	13232	Bobbin (5)
*225482	-----	" Case Screw Driver Blade
*225483	-----	" " " " Handle
225497	14334	Bobbin Case Screw Driver complete, Nos. 225482 and 225483
231337	14362	Cloth Guide
200861b	14362	" " Thumb Screw
135 x 17	-----	Needles, six, size 18
221121	-----	Drip Pan, 20 in. long, with four 1 in. wire nails
12361	14334	Machine Hinge Connection (2)
41400	14334	" Rest Pin (wood)
120342	14334	Oiler (copper plated) with 120343
120343	14334	" Spout, 3 1/2 in. long
*225484	-----	Screw Driver Blade
*225485	-----	" " Handle
225498	14334	Screw Driver complete (7 1/2 in. long), Nos. 225484 and 225485
225554	14334	Wrench (steel)

BOBBIN WINDER

Swing Automatic, Right Hand

225453	10884	Frame with 202277 and 225438
225454	10884	" Hinge Pin
202277	-----	" Oil Packing (wick)
225438	10884	" " Well Cap
225455	10884	" Spring
225456	10884	" " Plunger
202473	10885	Pulley with 200380c
200380c	14362	" Set Screw
225381	10884	Spindle
225444	10884	Stop Latch
200056e	10884	" " Screw
225458	10884	" " Thumb Lever
225459	10884	" " " " Hinge Stud
225459	10884	" " " " Joint Stud
202478	10884	" " Trip Lever
200299a	10884	" " " " Hinge Screw

Accessories

No.	Plate	Name
225461	10881	Tension Bracket with 201499b
200082b	10881	" " Screw
228026	10884	" " Washer
2102	10881	" Disc
202407	10881	" Spring
201499b	10881	" Stud
201572b	10881	" " Thumb Nut
225462	10881	Bobbin Winder Tension Bracket complete, Nos. 201572b, 202407, 225461 and two 2102
225433	10885	Bobbin Winder and Tension Bracket Base
225382	10885	Universal Bobbin Winder complete, Nos. 200056e, 200082b, 200299d, 202473, 202478, 225381, 225433, 225444, 225453 to 225456, 225458, 225462, 228026, two each 225459 and wood screws $\frac{3}{4}$ in., No. 12, R.H.B.
KNEE LIFTER		
2763	13395	Rock Shaft
228278	13395	" " Hanger (back) with 356c
228279	-	" " " 228278 with 202452 and 228282
228280	13395	Rock Shaft Hanger (front) with two 356c
228281	-	Rock Shaft Hanger 228280 with 202452 and 228282
228282	13395	Rock Shaft Hanger Bracket with two wood screws $\frac{3}{4}$ in., No. 12
202452	14335	Rock Shaft Hanger Hinge Pin
228283	13395	" " Lifting Lever with two 356c
227728	13395	Rock Shaft Lifting Lever Rod with 227729
227729	-	Rock Shaft Lifting Lever Rod Cap
356c	14362	" " " " " Set Screw
356c	14362	Rock Shaft Lifting Lever Set Screw
202455	13395	" " Knee Arm
356c	14362	" " " " Set Screw
228284	13395	" " " Plate with 356c
356c	14362	" " " " Set Screw
356c	14362	" " Set Screw

Accessories

No.	Plate	Name
228285	13395	Knee Lifter Rock Shaft complete, Nos. 2763, 202455, 227728, 228279, 228281, 228283 and 228284
THREAD UNWINDER		
225325	14263	Spool Rest (for two spools) with 201018c
225388	14263	Spool Rest Rod
200383c	14357	" " " Set Screw
201018c	14335	" " Set Screw
202490	14263	" Stand with 200383c
225391	14263	Thread Guide
201696j	14335	" " Lock Nut
225326	14362	" " Position Cup
225324	14263	" " Rod with 208E and 225322
208E	14335	Thread Guide Rod Screw
225322	14362	" " " Washer
225396	14263	Thread Unwinder (for two spools) complete, Nos. 201696j, 202490, 225324 to 225326, 225388, two 225391 and three wood screws $\frac{3}{4}$ in., No. 12

FOR MACHINE No. 111w105

Same as for Machine No. 111w104 with the following exception:

135 x 17 Needles, six, size 24, in place of six, size 18

FEED DOGS

No.	Plate	Name
240105	14344	Feed Dog, 46 needle hole, for needle sizes 16 and 18, for 240143
240106	14344	Feed Dog, 40 needle hole, for needle sizes 20 and 22, for 240144
240107	14344	Feed Dog, 46 needle hole, for needle sizes 16 and 18, for 240144
240108	14344	Feed Dog, 50 needle hole, for needle sizes 14 and 15, for 240144
240109	14351	Feed Dog, 50 needle hole, for needle sizes 14 and 15, for 240145
240110	14351	Feed Dog, 46 needle hole, for needle sizes 16 and 18, for 240145
240111	14351	Feed Dog, 40 needle hole, for needle sizes 20 and 22, for 240145

PRESSER FEET

240128	14344	Lifting Presser Foot, for closing gloves, for 240150 to 240152
240133	14344	Lifting Presser Foot, for 240153
240130	14351	" " " " cording and general upholstery, for 240154
240132	14351	Lifting Presser Foot, for 240156
240133	14351	" " " " 240153
240134	14351	" " " " 240157
240150	14344	Vibrating Presser Foot, 38 needle hole, with 201015e, for closing gloves, for 240128
240151	14344	Vibrating Presser Foot, 50 needle hole, with 201015e, for 240128
240152	14344	Vibrating Presser Foot, 46 needle hole, with 201015e, for 240128
240153	14344	Vibrating Presser Foot, 40 needle hole, with 201015e, for 240133
240154	14351	Vibrating Presser Foot, 40 needle hole, with 201015e, for 240130
240156	14351	Vibrating Presser Foot, 46 needle hole, with 201015e, for 240132
240157	14351	Vibrating Presser Foot, 46 needle hole, with 201015e, for 240134

THROAT PLATES

No.	Plate	Name
240143	14344	Throat Plate, for 240105
240144	14344	" " " 240106 to 240108
240145	14351	" " " 240109 to 240111

FOOT LIFTER

223733	14335	Foot Lifter Lifting Lever Extension
200082b	10881	" " " " " " Screw
227561	14335	Foot Lifter Lifting Lever Spring

MISCELLANEOUS PARTS

60913	14263	Spool Weight with 60914
60914	-	" " Center Pin
225377	14263	" Wire, for small spools

PLATE 10881—FULL SIZE

225461

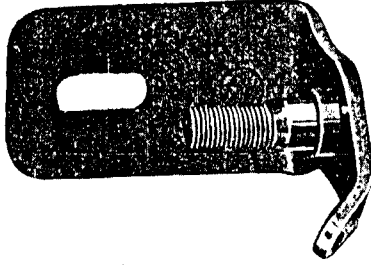

200082



202104



2102

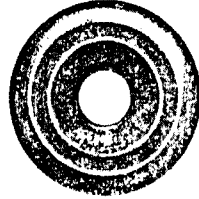

225462

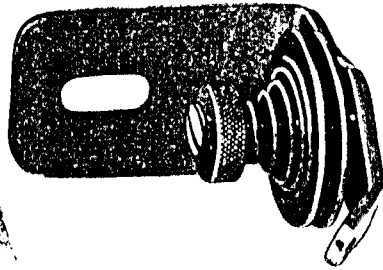

202407



201499



201572



PLATE 10884—FULL SIZE

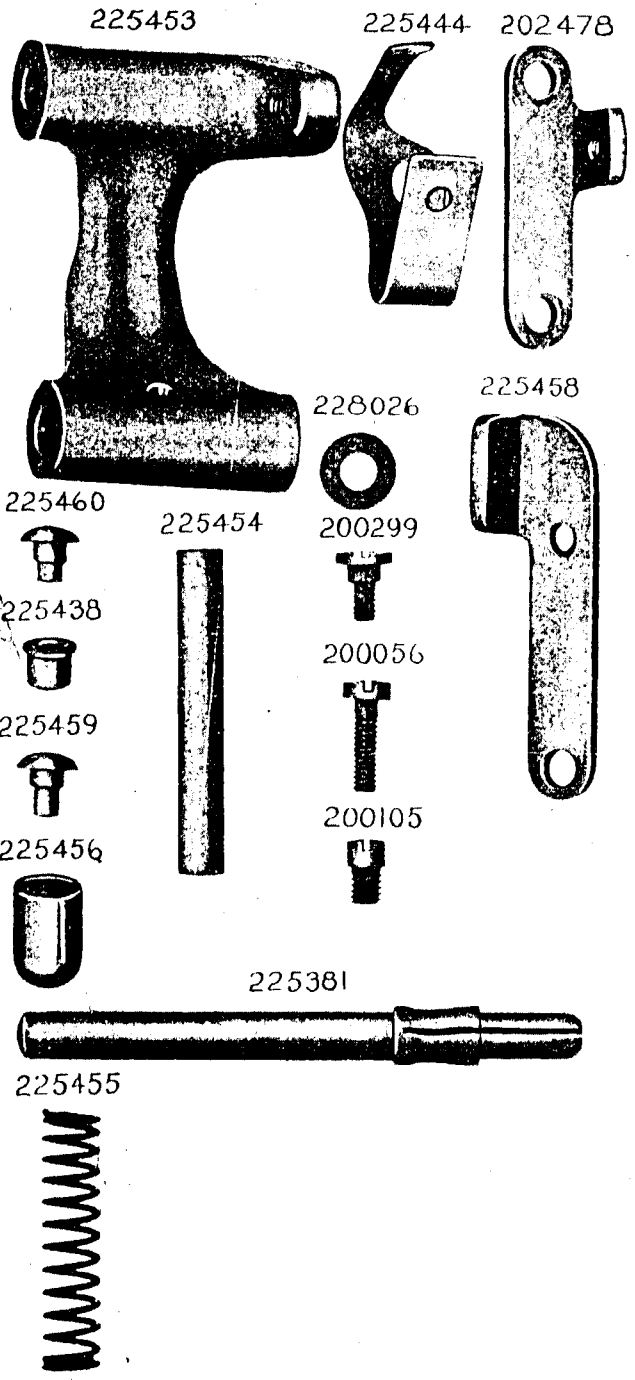
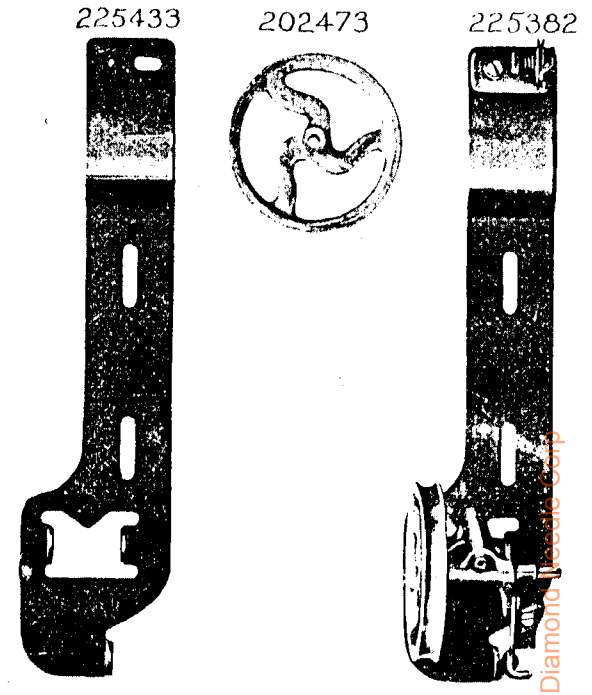

PLATE 10885—ONE-FOURTH SIZE



From the library of: Diamond Records Corp

PLATE 13232 - FULL SIZE

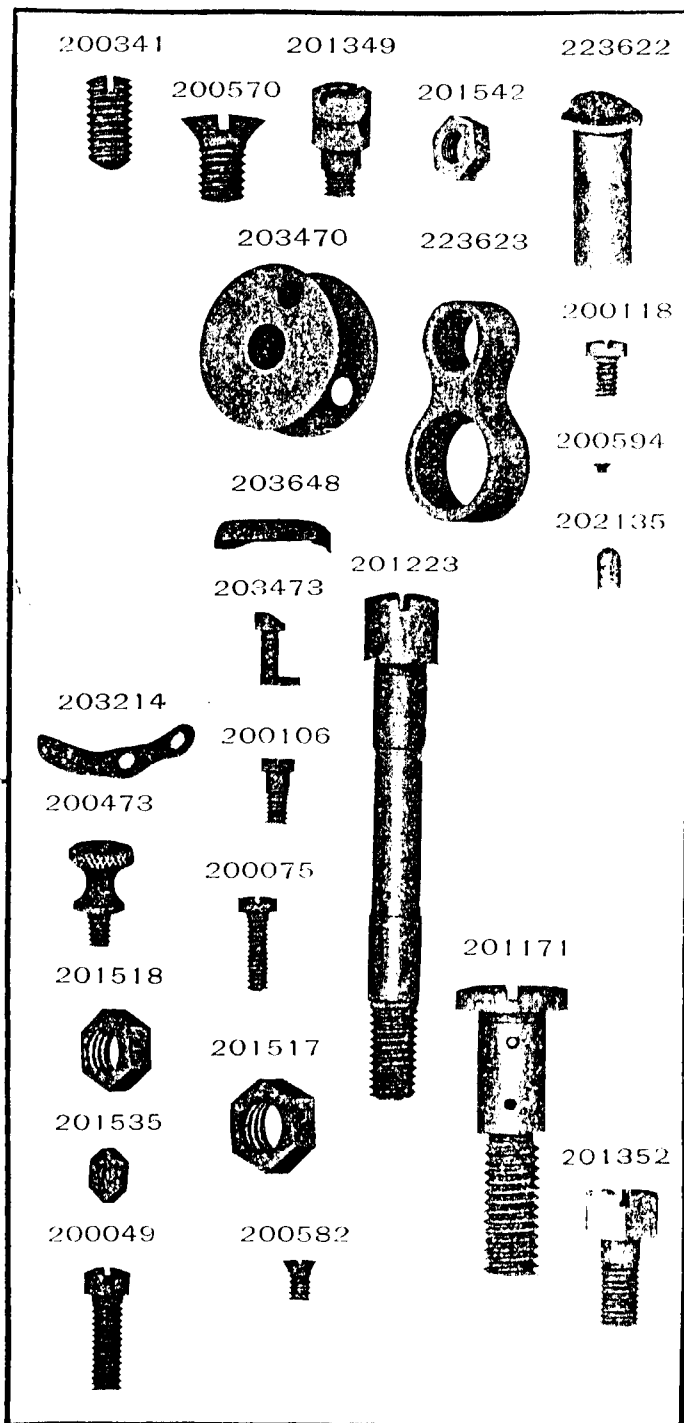

PLATE 13234 - FULL SIZE

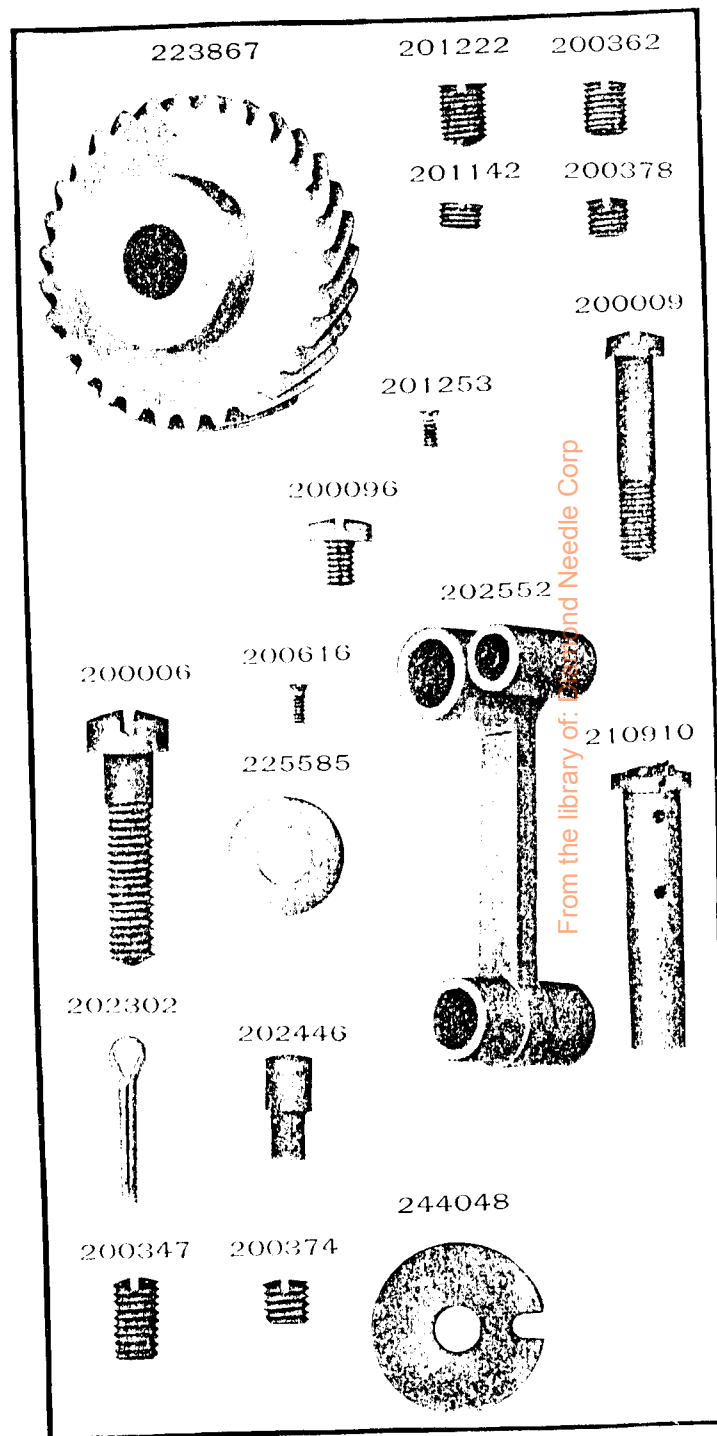

PLATE 13395—ONE-FOURTH SIZE

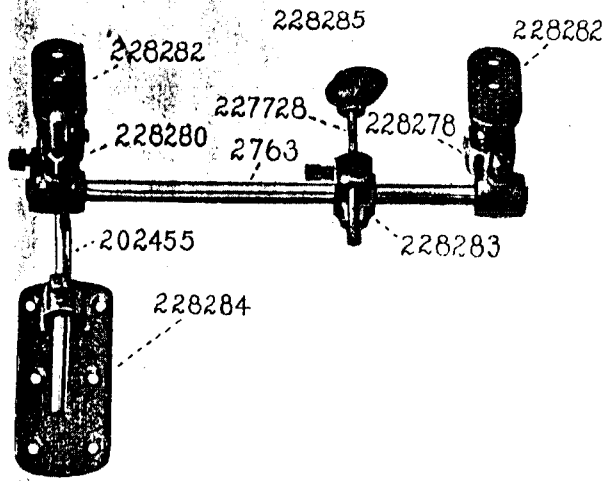
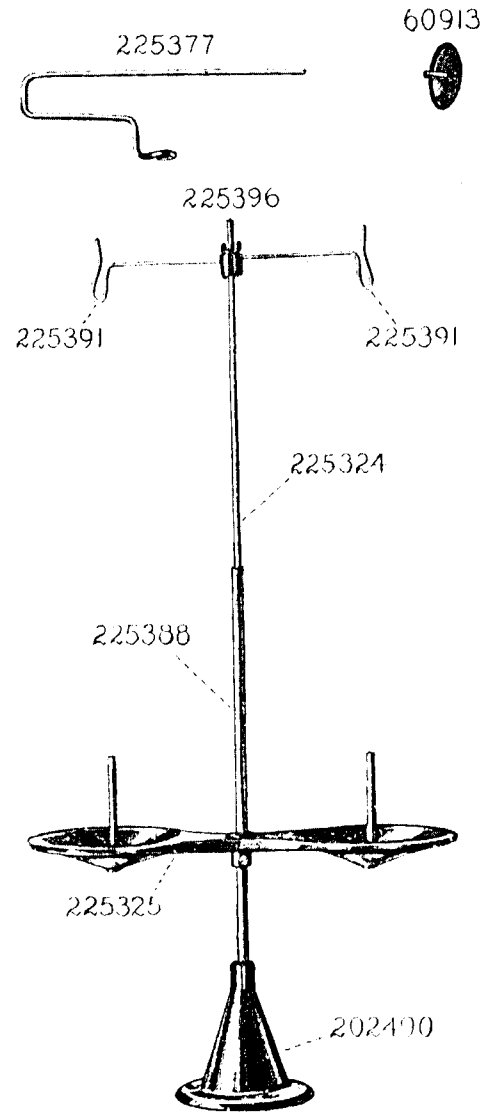

PLATE 14263—ONE-SIXTH SIZE



From the library of: Diamond Needle Corp

PLATE 14327—FULL SIZE

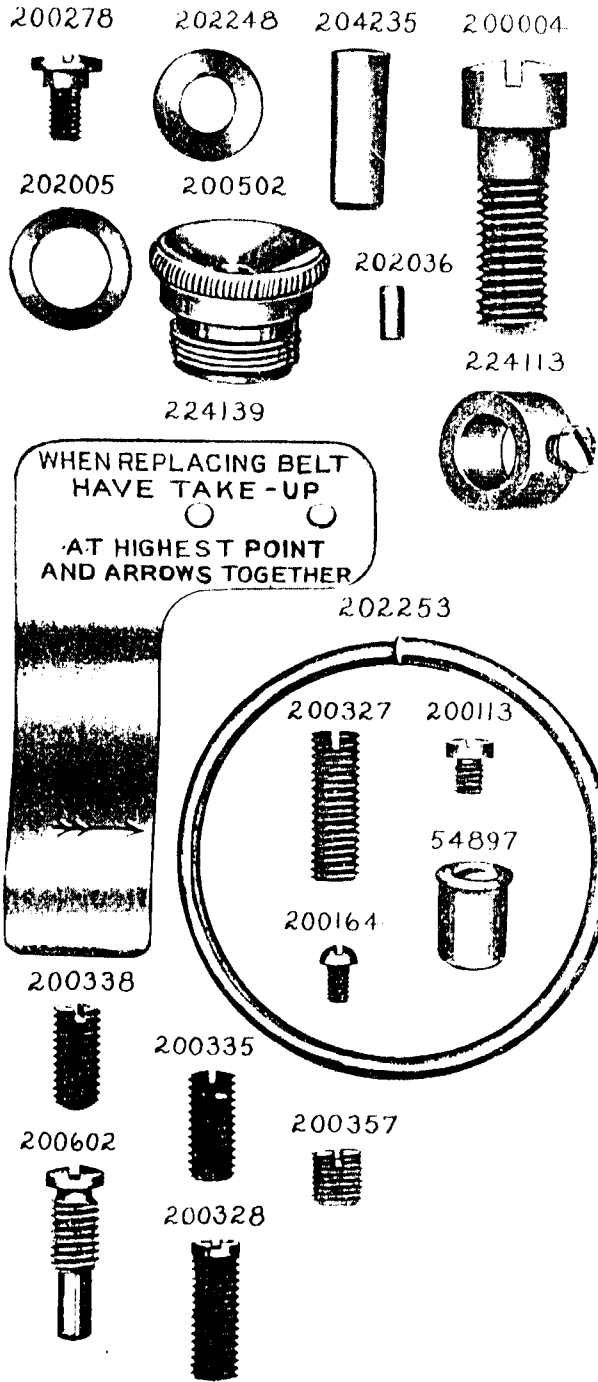
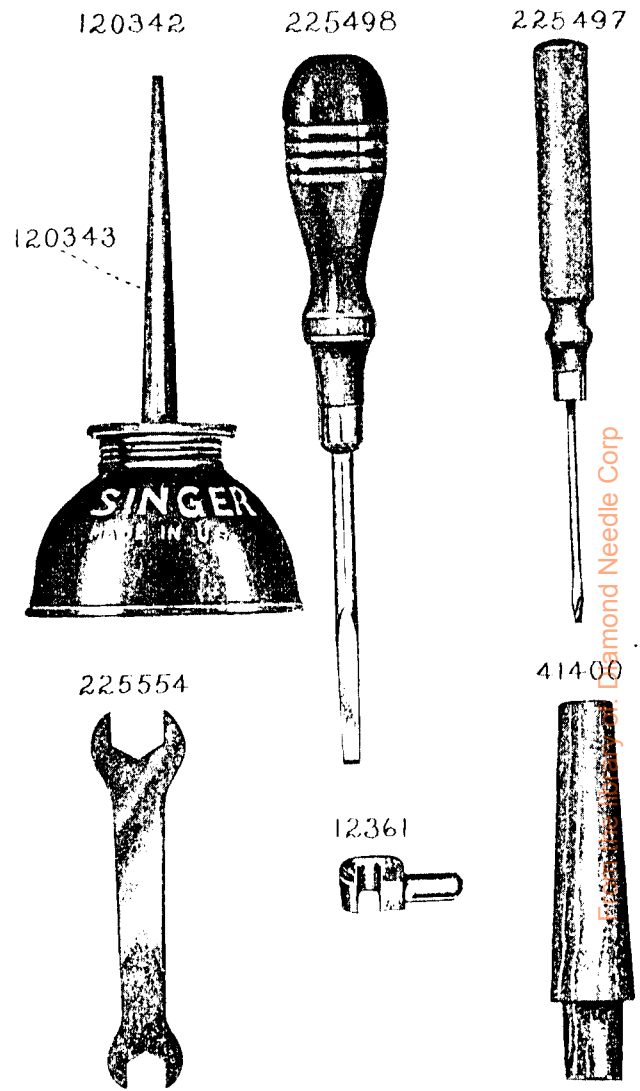

PLATE 14334—ONE-HALF SIZE



© 1954 Singer Sewing Machine Co. Diamond Needle Corp.

PLATE 14335—FULL SIZE

223733



227561

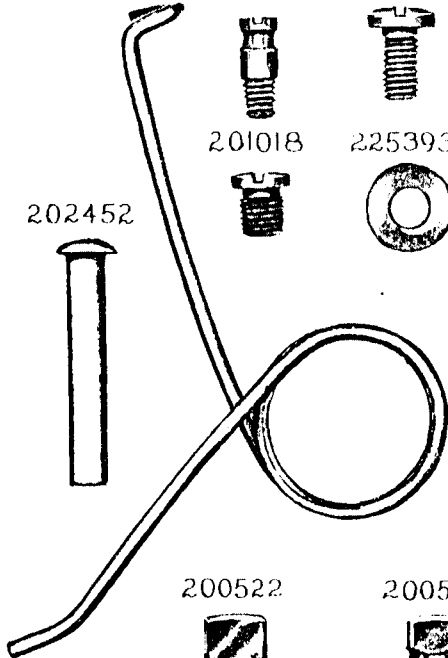

200835



201018



200157



225393



202452



200522



200526



200529



201696



208

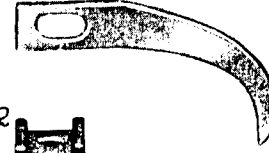

PLATE 14338—FULL SIZE

223811



224004



203521

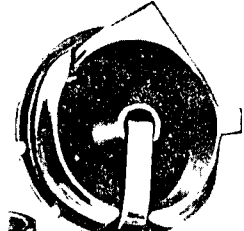

223812



224005



202625

203474



200364



200429



223652

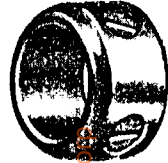
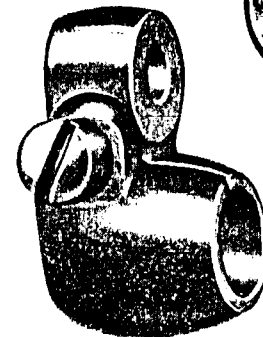

225837

200984



200437

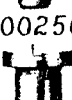

200019



200446

200256



224052

202619

201525

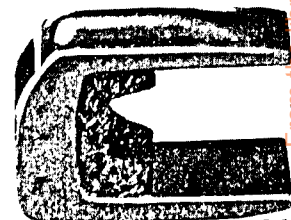

202443

200607



202301



200173



224019

224154

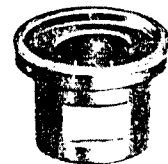
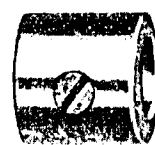

237523



350197



201220



224020



From the library of: Diamond File

PLATE 14339—ONE-HALF SIZE

240037

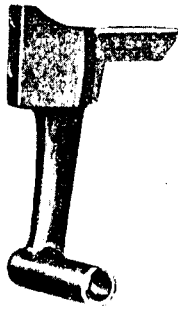

237521

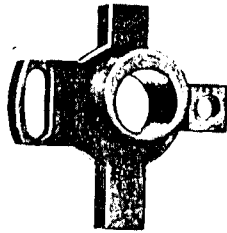

224108

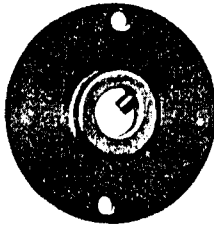

224111



237529



223681



237565



224122



224112

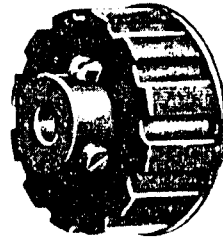

224024

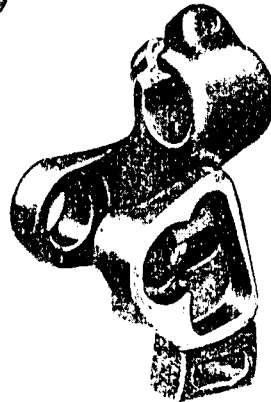
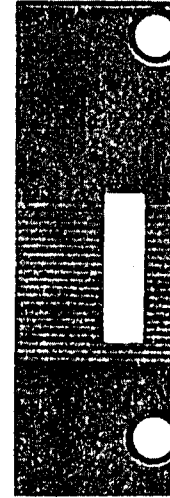

PLATE 14344—FULL SIZE

240143



240144



240105

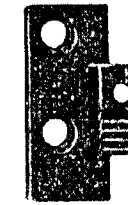

240106
240107
240108



240133



240128



240150
240151
240152



240153



From the library of: Diamond Ne

PLATE 14347—ONE-HALF SIZE

224002

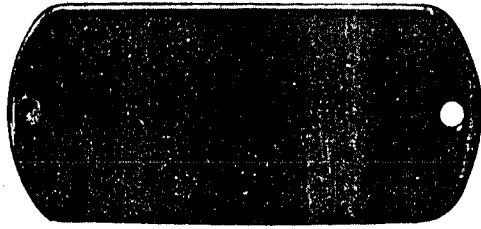

207080

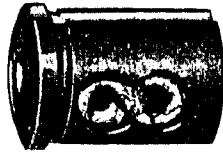

202243

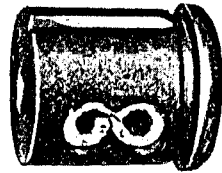

240004

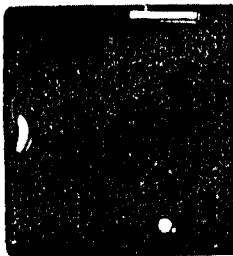

240003

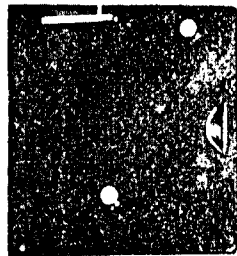

237837



224104

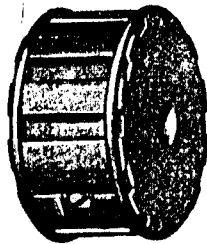

240045

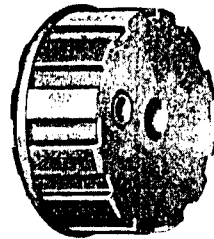

PLATE 14348—ONE-HALF SIZE

223650



223691



224103



PLATE 14350—FULL SIZE

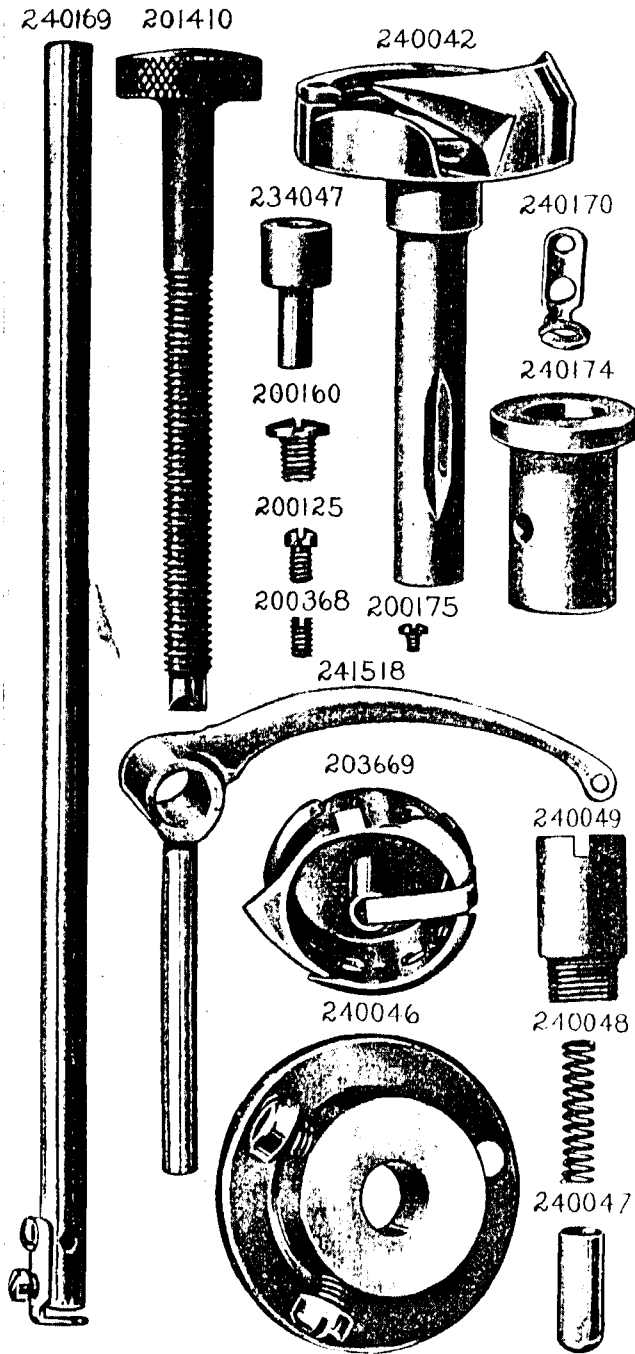
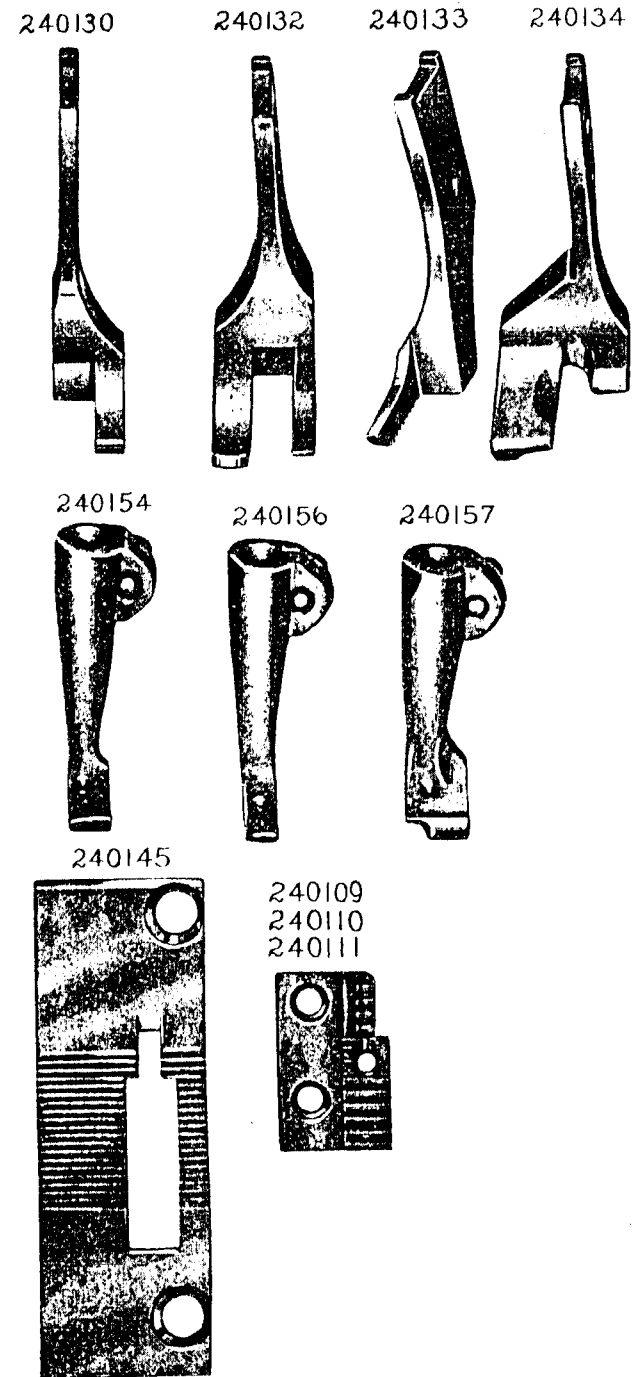

PLATE 14351—FULL SIZE



From the library of: Diamond Needle Corp

PLATE 14357—FULL SIZE

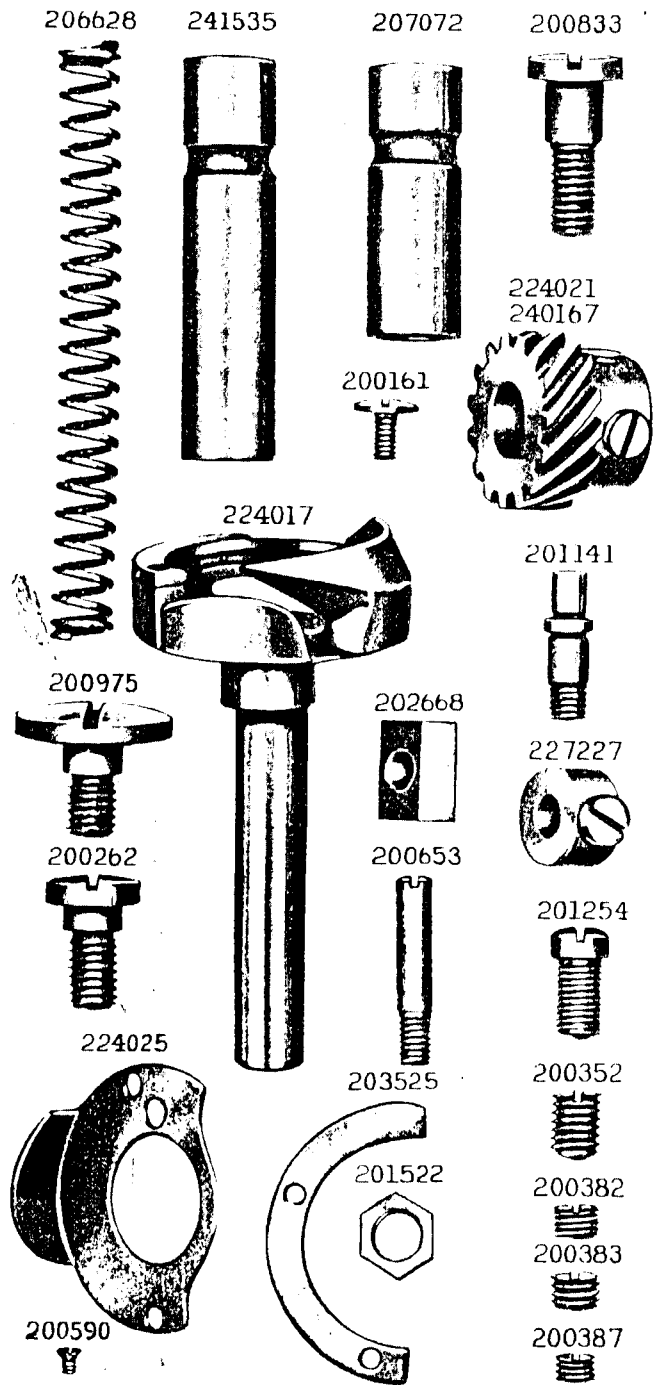

PLATE 14358—ONE-HALF SIZE

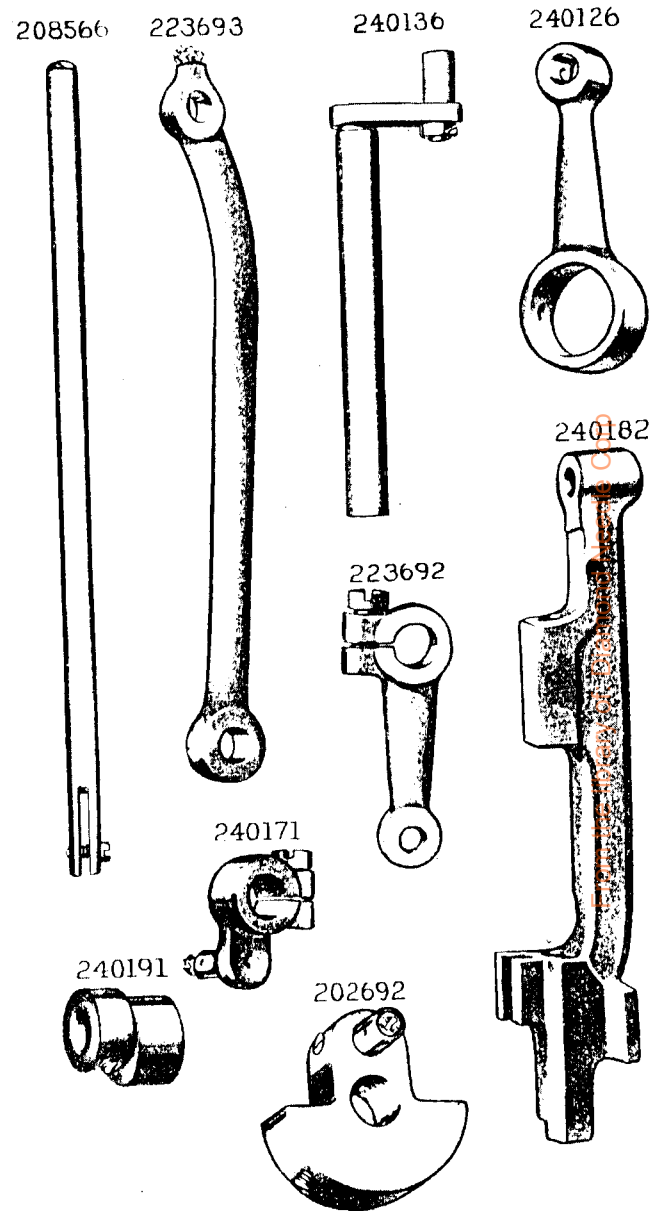

PLATE 14359—ONE-FOURTH SIZE

240102 234147 240018 240017

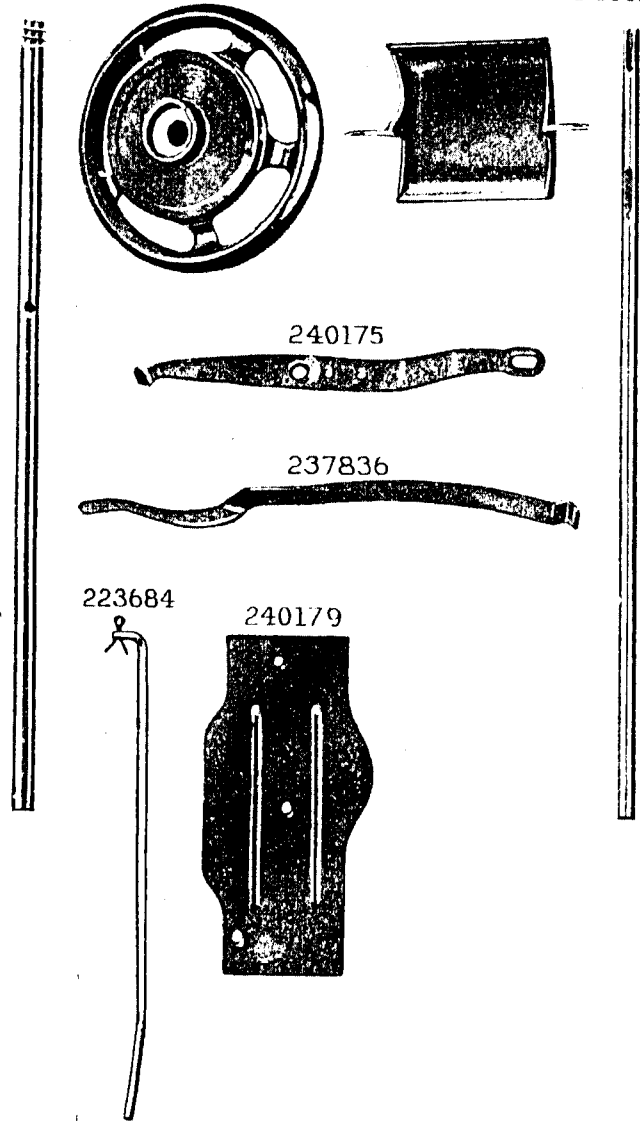

PLATE 14360—FULL SIZE

240139

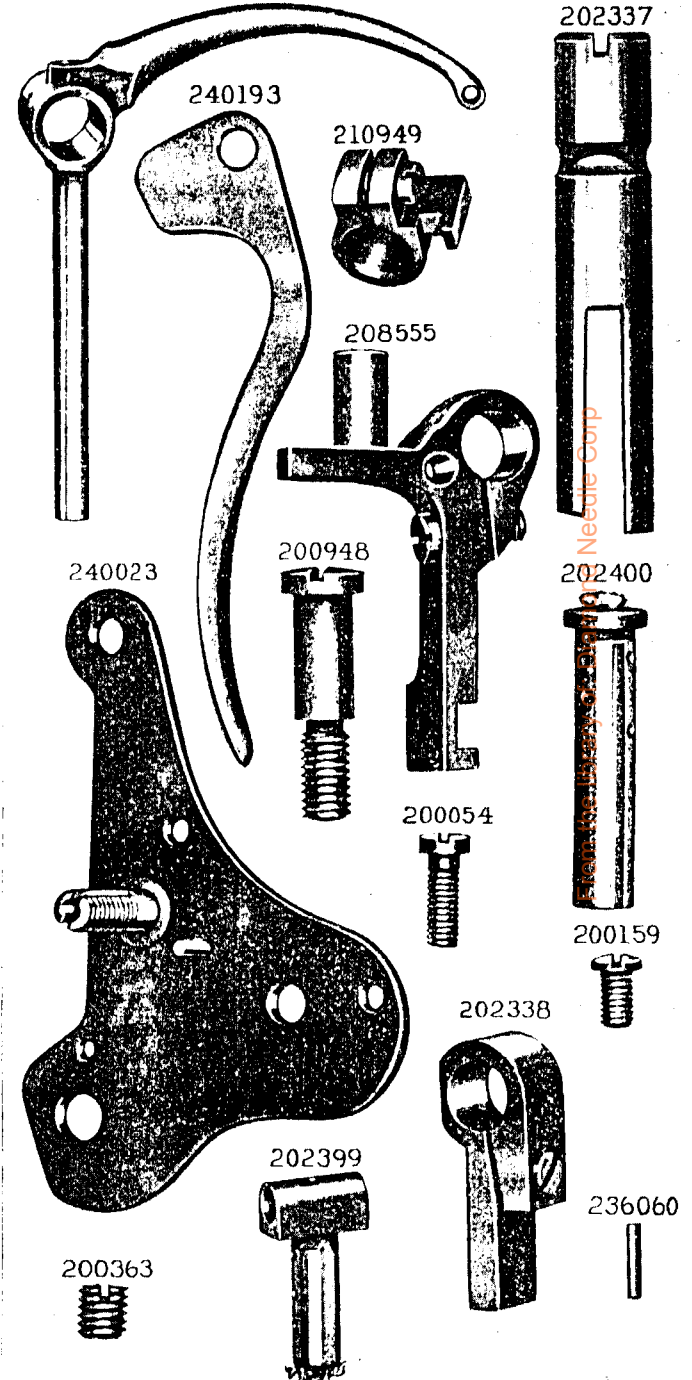

PLATE 14361—FULL SIZE

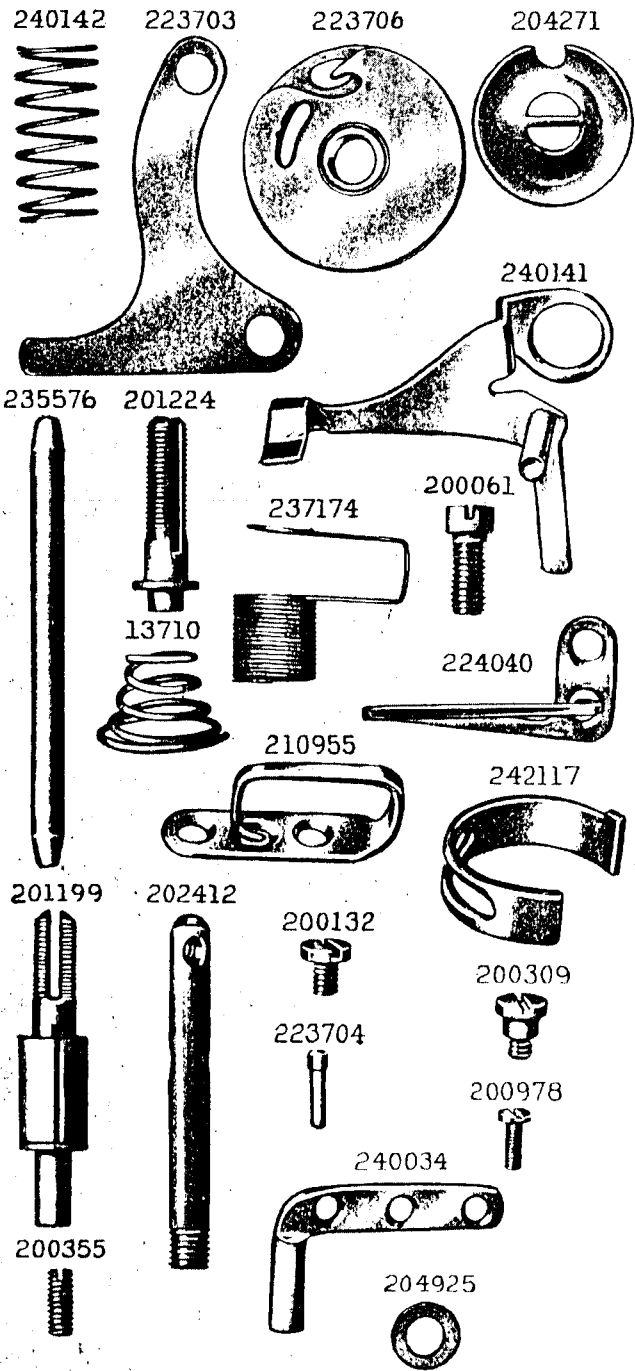
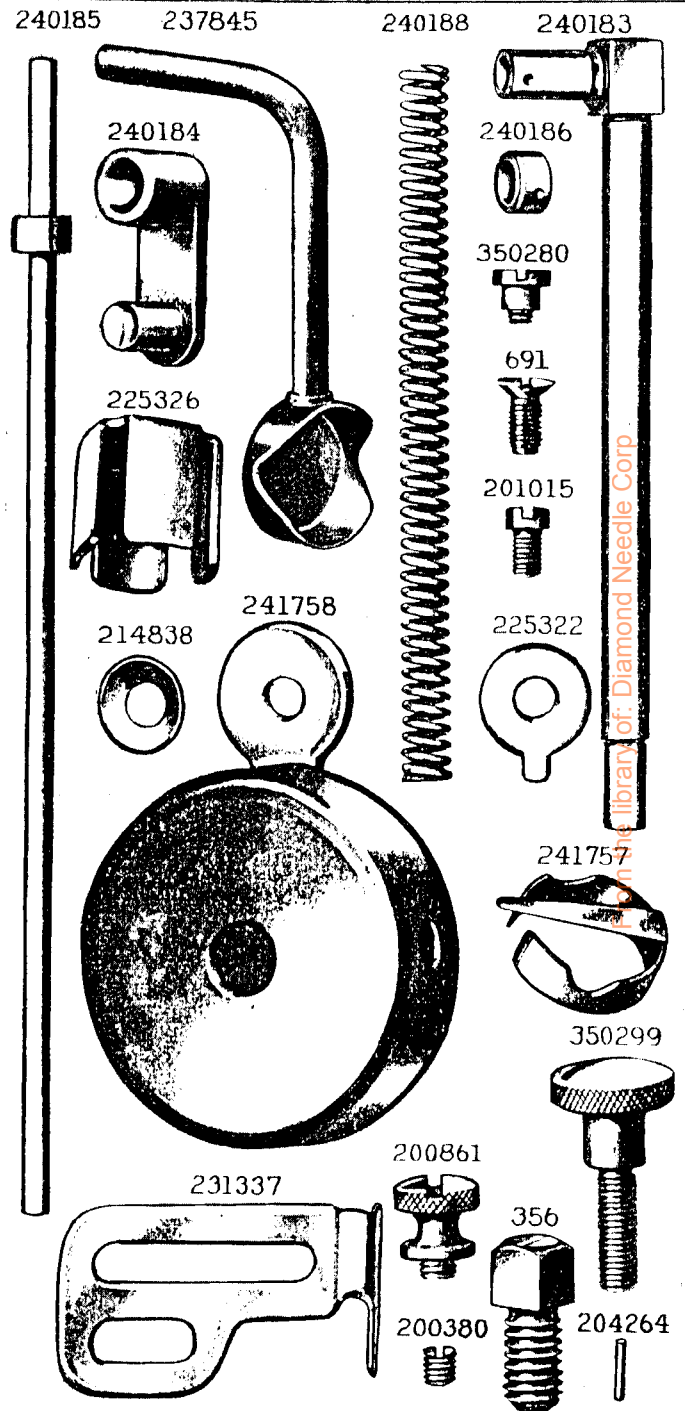

PLATE 14362—FULL SIZE



Library of Diamond Needle Corp.

PLATE 14472—FULL SIZE

